

CRANE 01B2SER_400

LIFTING CAPACITY 200 KG
COUNTERBALANCED SWIVEL CRANE ELECTRIC LIFT/LOWER/EXTEND/RETRACT
THROUGH PUSH BUTTON REMOTE CONTROL



Model		01B2SER_400
Drive		Manual
Rotation		360° manual - slewing bearing system
Arm lifting		Electric – remote control
Arm lowering		Electric – remote control
Arm extension		Electric – remote control
Width with arm not rotated	mm/inch.	780 / 30
Width with arm rotated at 90°	mm/inch.	1040 / 41
Max capacity with standard arm	Kg / lbs.	200 / 440 * see load chart below
Max capacity with extension PZG_SE	Kg / lbs.	70 / 154 * see load chart below
Weight of the crane (counterweight incl.)	Kg / lbs.	445 / 981
Battery type standard		Lead acid
Batteries nos.	pcs	1
Battery voltage / nominal capacity	V / Ah	12 / 80
Lifting motor	W	-
Traction motor	W	-

CRANE 01B2SER_400 MAIN DIMENSIONS

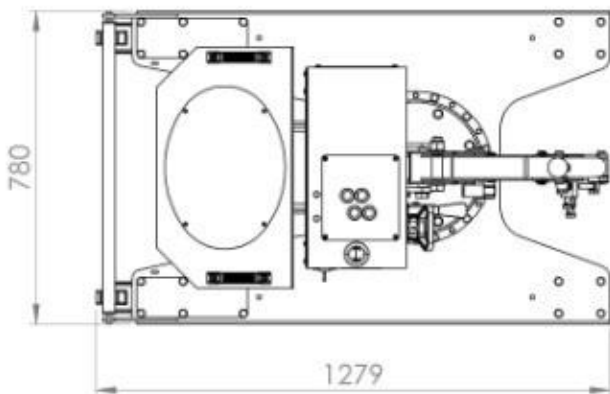
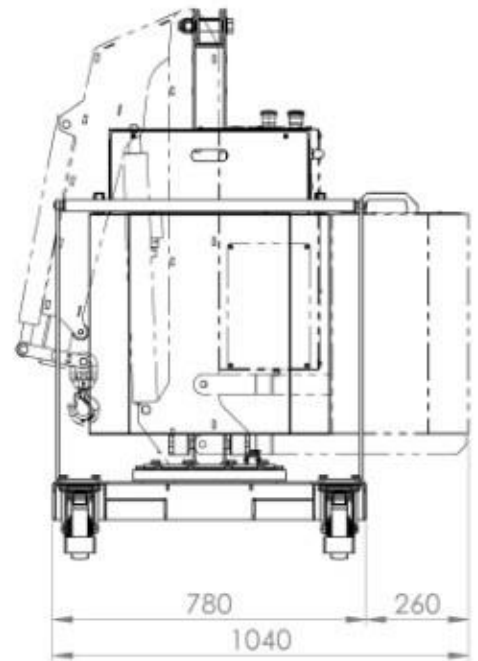
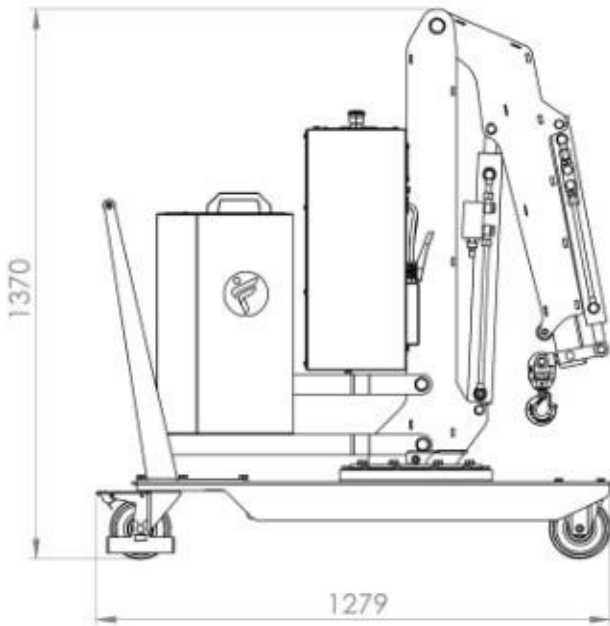

CRANE 01B2SER_400 DETAILED DIMENSIONS WITH STANDARD ARM

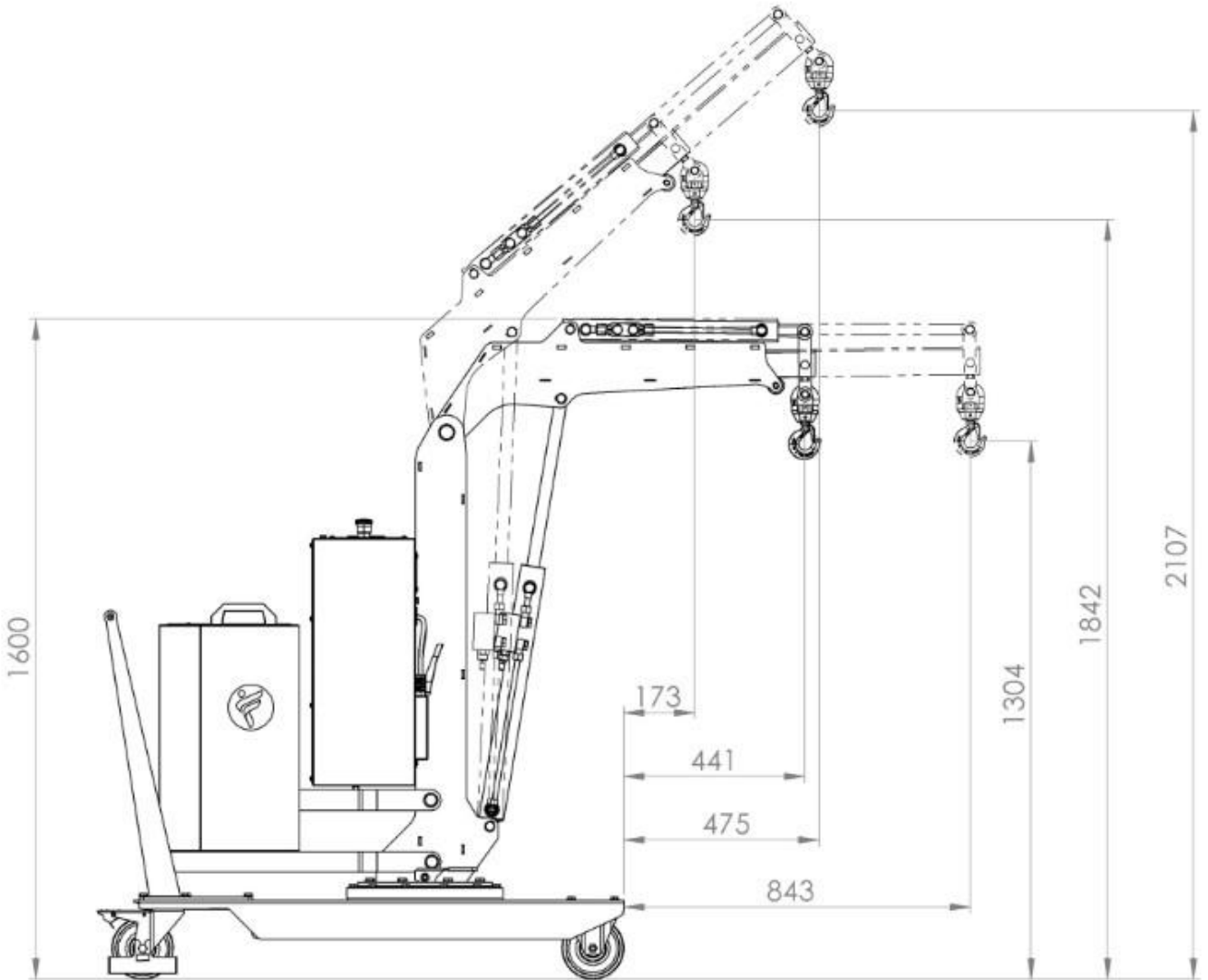

CRANE 01B2SER_400 MAIN DIMENSIONS

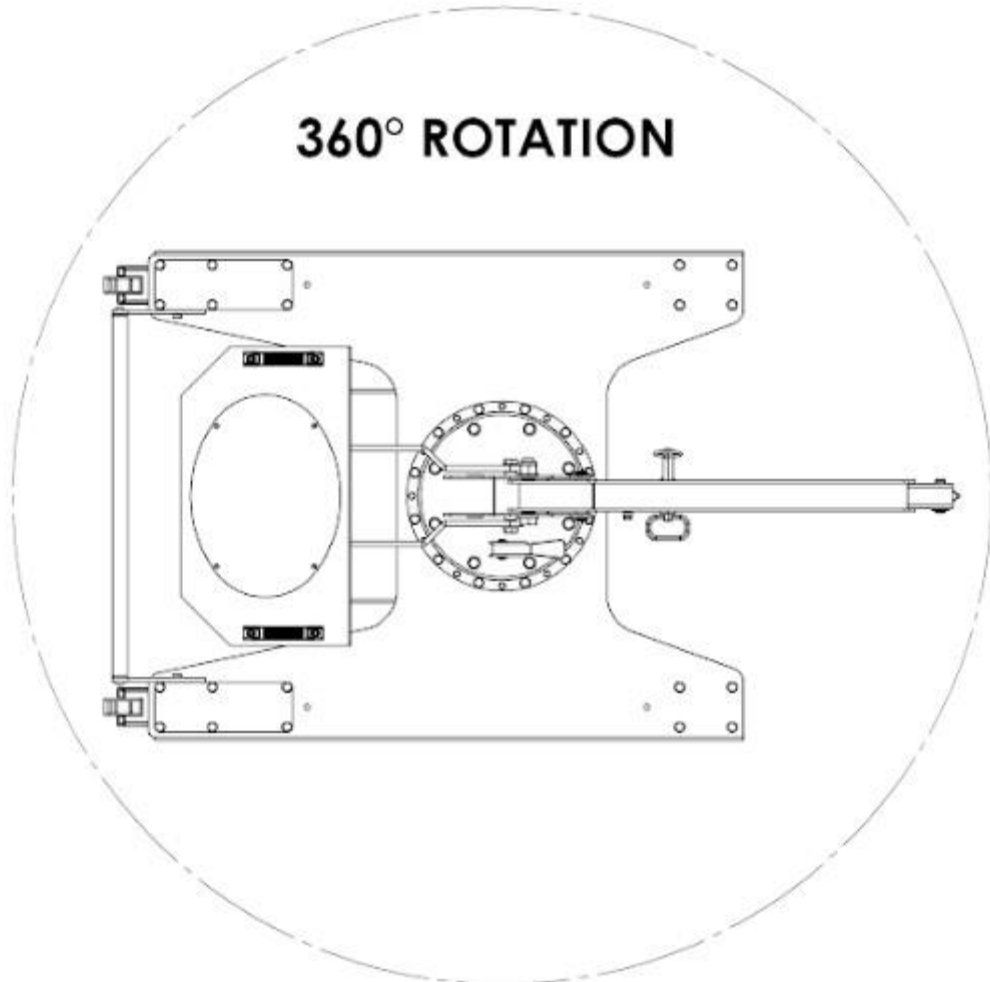

CRANE 01B2SER_400

LOAD CHART WITH STANDARD ELECTRIC ARM

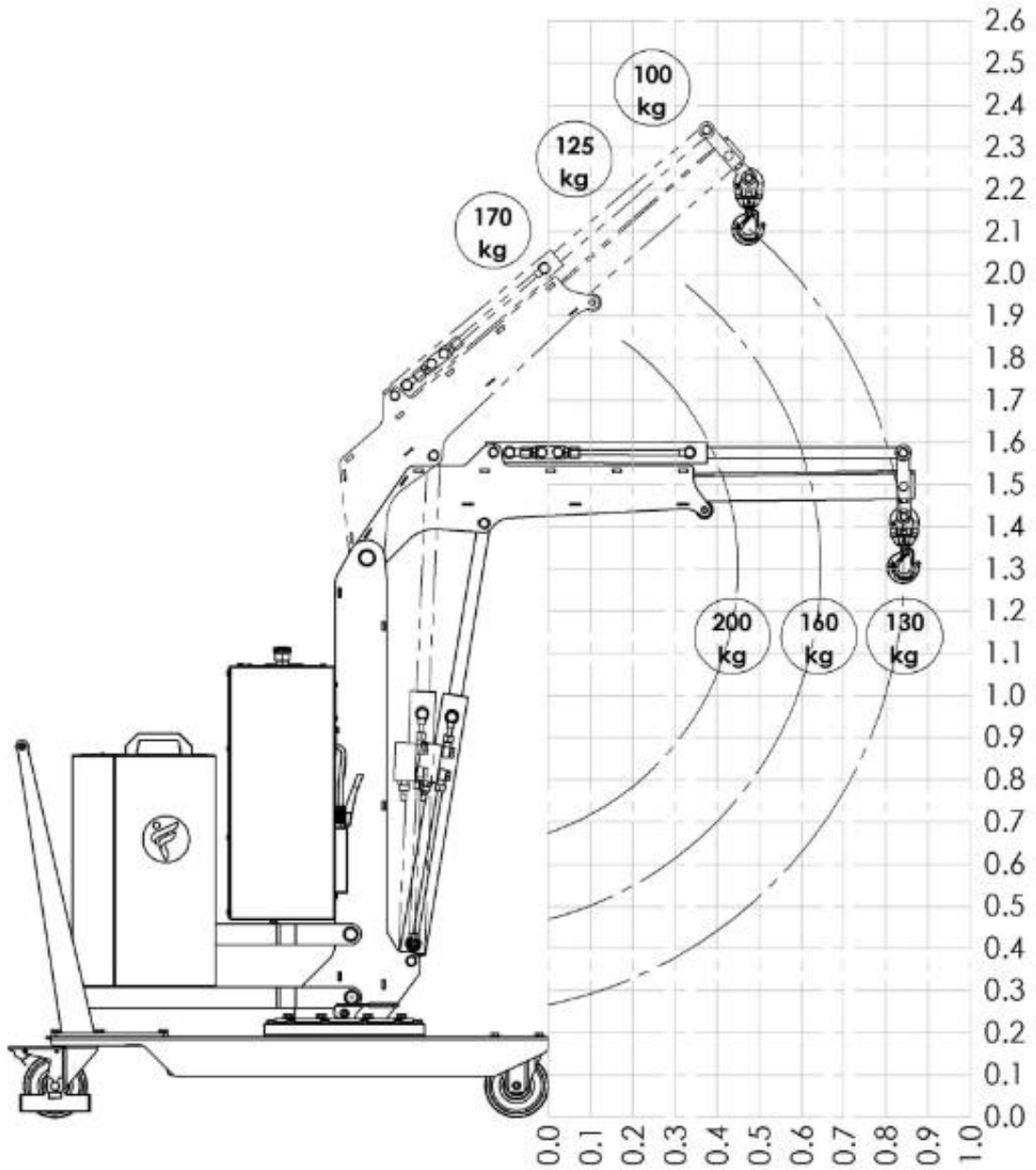

CRANE 01B2SER_400

LOAD CHART WITH OPTIONAL MECHANICAL EXTENSION PZG_SE

