

ALFA MGF evo | ALFA MGL evo

Drum, Barrel and Tank Handling

Capacity (kg): 300 (more capacity on demand) | Lifting Height (mm): 1880/1660 (higher lifting on demand)

ALFA MGF evo

The ideal solution to safely lift, transport, fill and empty drums and cylindrical containers. A mechanical clamp secures drums of varying diameters, and a hand operated turner precisely controls the forward rotation.



ALFA MGL evo

Version with hand operated turner that rotates and empties the drum to the side of the truck.

ATTACHEMENTS FOR SPECIAL APPLICATIONS

Features in detail: _____



MANUAL CLOSING:

A hand wheel closes the manual clamp and adjusts for different drum diameters.



MANUAL REDUCTION GEAR:

Hand operated mechanical rotator with reduction gears allows turning the drum with very little effort.

ALFA MRF evo | ALFA MRL evo

Tilting of industrial containers and cases

Capacity (kg): 400 | Lifting Height (mm): N.D.

ALFA MRF evo FRONTAL TILTER

The tilting forks make the picking of parts from containers safe and easy.

A hand operated pump tilts the load up to 85° to reach the bottom of the container.



ALFA MRL evo LATERAL TILTER

Side load tilting option with +/- 20° tilting angle.

ATTACHEMENTS FOR SPECIAL APPLICATIONS

Features in detail: _____



CUSTOM SOLUTIONS:

Armanni will customize the width and length of the forks to perfectly suit non-standard containers.



MANUAL OPERATION:

A safe and easy to use hand hydraulic pump powers the lifting or tilting function.



ALFA MGF evo

model	MGF
Q	Kg 300
C	mm 685
I	mm /
L	mm 1550
X	mm 405
Y	mm 1100
L2	mm 585
E	mm 650
F	mm 750
h1	mm 1990
h2	mm 1880
h3	mm 1880
h4	mm 2000
B	mm 800
WA	mm 1190

STANDARD EQUIPMENT

- Manual drum tipper with reducer (300 kgs capacity)
- Lifting by fast manual pump (without load)
- Descent by lever
- 360° frontal drum rotation
- Parking brake
- Polyurethane single roller
- Polyamide wheels with polyurethane covering
- Safety components
- Manual traction

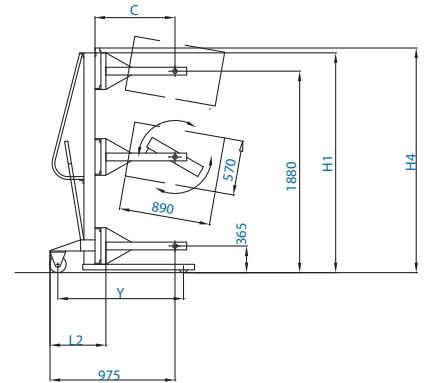
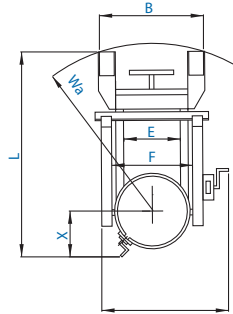

ALFA MGL evo

model	MGL
Q	Kg 300
C	mm 370
I	mm /
L	mm 1465
X	mm 280
Y	mm 1115
L2	mm 585
E	mm 650
F	mm 750
h1	mm 1990
h2	mm 1330
h3	mm 1660
h4	mm 2300
B	mm 800
WA	mm 1190

STANDARD EQUIPMENT

- Manual drum tipper with reducer (300 kgs capacity)
- Lifting by fast manual pump (without load)
- Descent by lever
- 360° lateral drum rotation
- Parking brake
- Polyurethane single roller
- Polyamide wheels with polyurethane covering
- Safety components
- Manual traction

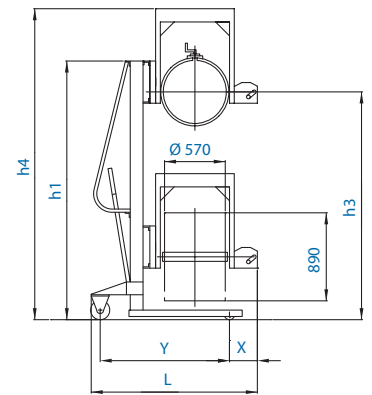
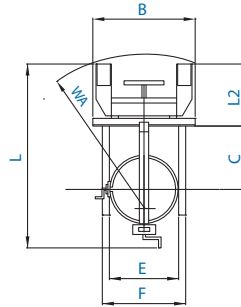

ALFA MRF evo FRONTAL TILTER

model	FRONTAL
Q	Kg 1000
C	mm 400
I	mm 800
L	mm 1315
X	mm 50
Y	mm 1195
L2	mm 515
M	mm 560
N	mm 120
h1	mm 1120
h2	mm 900
h3	mm 900
h4	mm 1645
B	mm 735
F	mm 355
S	mm 55
WA	mm 1320

STANDARD EQUIPMENT

- Rated capacity 1000 Kgs
- Lifting by manual double acting pump
- Descent by lever
- Fixed forks length mm. 800
- 85° max. tilting frontal angle
- Parking brake
- Polyurethane single roller
- Polyamide wheels with polyurethane covering
- Safety components
- Manual traction

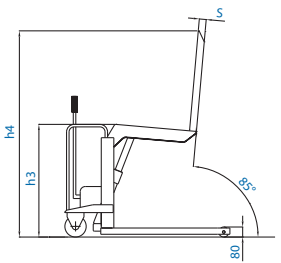
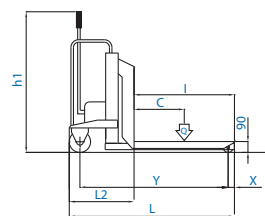
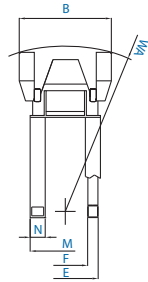

ALFA MRL evo LATERAL TILTER

model	LATERAL
Qf	Kg 1000
Qr	Kg 400
C	mm 450
I	mm 900
L	mm 1420
X	mm 176
Y	mm 1140
L2	mm 520
M	mm 445
N	mm 30
h1	mm 1230
h2	mm 800
B	mm 755
E	Kg 724
F	mm 540
S	mm 70
WA	mm 1265
à	mm 20°

STANDARD EQUIPMENT

- Rated capacity 1000 Kgs (Qf)
- Side tilter capacity 400 Kgs (Qr)
- Lifting by fast manual pump (without load)
- Descent by lever
- Fixed forks length mm. 900
- Tilting angle from -20° to +20°
- Parking brake
- Polyurethane single roller
- Polyamide wheels with polyurethane covering
- Safety components
- Manual traction

